

Technical Manual



JBL 3722-HF

SPECIFICATIONS

ACOUSTIC & ELECTRICAL SPECIFICATIONS:

- Nominal Impedance: 4 Ohms
- Passive System Power Rating: 400 W
- Frequency Range: 30 Hz - 20 kHz
- Rated Maximum SPL: 127 dB, @ 1 m (3.3. ft) 133 dB peak
- System Sensitivity: 101 dB, 2V @ 1 m (3.3 ft)
- Crossover Frequency: 1300 Hz

SYSTEM COMPONENTS:

- Cabinet: Not for Sale
- High Frequency: 2418H-1 compression driver
- Pack: 1 x 2374 HF horn, one adjustable bracket
- DC Resistance: 3.7 ohms ± 5 % (?)

SYSTEM COMPONENTS: (Cont'd)

- Crossover Network: 442115-001

AURAL SWEEP TEST SPECIFICATIONS:

- A. System Aural Sweep Test: 3.0V Input, 500 Hz to 20 kHz

PHYSICAL SPECIFICATIONS:

- Enclosure Dimensions: 381 x 762 x 381 mm D (15 x 30 x 15 in. D)
- Net Weight: 20 lb (9 kg)
- Shipping Weight: 32 lb (14.5 kg)

WARRANTY INFORMATION:

- Refer to Warranty Statement packed with each product.

PACKAGE

Warranty Card
59660

Carton
336997-001

Filler, Bottom
336998-001

Sleeve, Center
336999-001

Filler, Top
337000-001

Bag
322591-001
19" x 16" x 42" LRG
.003 THKLDPE
CLEAR

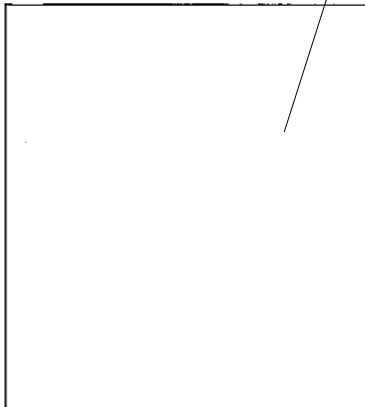

WIRING DIAGRAM

Driver, High Freq.
2418H-1
Diaph Repl
D8R2418-1

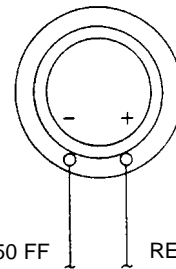

BLK - 0.250 FF RED + 0.205 FF

JBL 3722-HF

COMPONENT EXPLODED VIEW

Driver, High Freq.
2418H-1
(125-50000-01X)
Diaph Repl
D8R2418-1

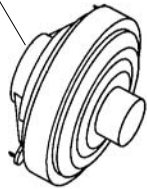

Waveguide
365359-002

Hole Plug (8)
410465-001

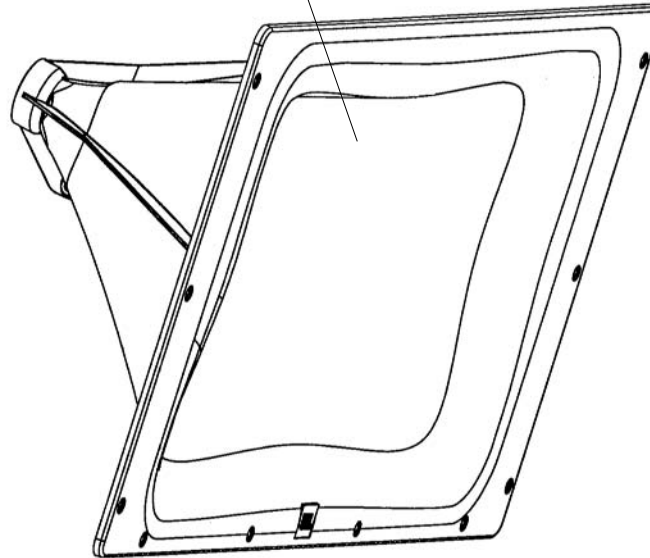

Bracket, Adjust Bar (2)
365489-001

Nut (3)
883-30110-00
10-32
KEPS, BLK ZINC, LCS,
RIGHT

Screw (1)
804-41110-16
10-32 x 1
PAN,PH,BLK ZINC
LCS

Washer (6)
843-00110-06
10 x .06
FLT,PL, REG,BLK ZINC,
CS

Screw (2)
804-41110-12
10-32 x 3/4
PAN,PH,BLK ZINC,
LCS



Network Assy
442115-001

Cable, Tie (2)
423-00014-00
PANDUIT,#PLT
1.51.5M-C
(BLK)

Nut (2)
364173-001
#8
NYLON NUT

Screw (2)
803-11010-08
8-32 x 1/2
FLT,PH,BLK,
ZINC,LCS

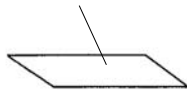

Label, Polarity Cinema
337853-001

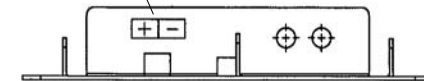

Bracket, Base
365487-001

Label
442193-004

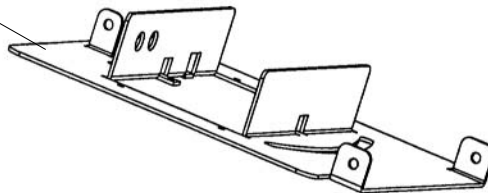

Bracket, Horn Hinge
365488-001

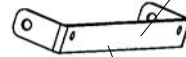

Screw (2)
804-41110-12
10-32 x 3/4
PAN,PH, BLK ZINC,
LCS

Screw (2)
806-31016-12
1/4-20 x 3/4
TR,PH,BLK
ZINC.SS

Nut (2)
834-36010-00
1/4-20 NYLOC, BLK

Washer (2)
844-00110-00
1/4
REG,BLK,ZINC,LCS

JBL 3722-HF